









Product datasheet

Product name	Internal extractor For extracting inner bearings, bearing outer rings and bushings.
Product number	21-6
Product series	21
EAN	4021176011566



Technical attributes

Attribute name	Attribute value
 ball bearing ISO	6007; 6207; 6307; 6407; 16007; 61807; 61907; 6008; 6208; 6308; 6408; 16008; 61808; 61908; 6009; 6209; 6309; 6409; 16009; 61809; 61909
 inner diameter of ball bearing	35 - 46 mm (1 3/8 - 1 7/8 inch)
 effective depth	50 mm (2 inch)
 length of internal extractor	113 mm (4 3/8 inch)
 number of segments	2
 weight	0.7 kg

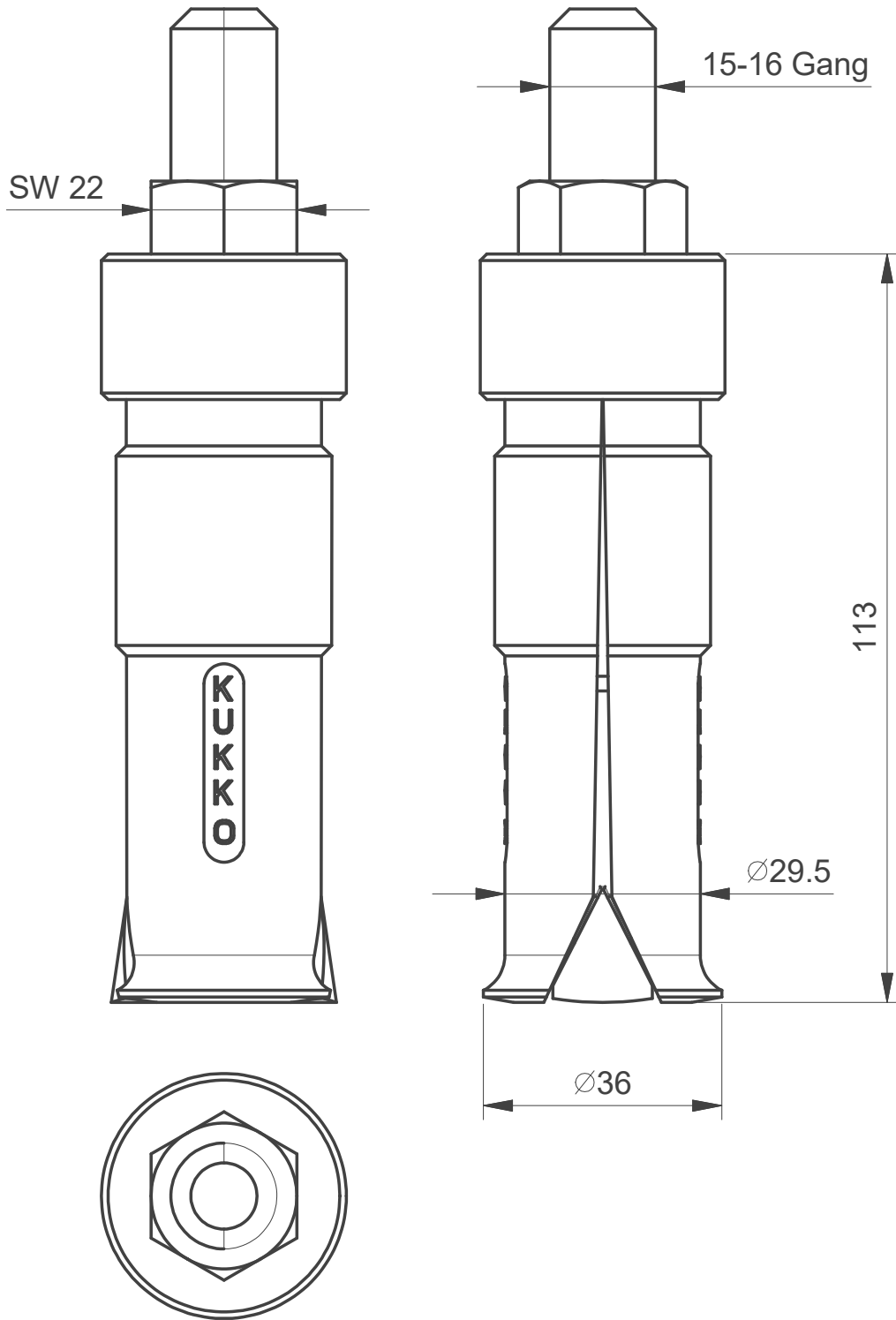

**Kleinbongartz
& Kaiser
oHG**
Werkzeugfabrik
Hilden - Germany

Dokumentname:
21-6 Innenauszieher

Toleranz:
DIN ISO 2768-m

Dokumentbeschreibung:
Baugruppe

Material:
Hochfester extra zäher Vergütungsstahl/
High tensile strength and toughness steel

Erstellt / Geprüft von:
Schultes

Erstellungsdatum:
30/03/2015

Maßstab:
1:1

Teilbeschreibung:
Innenauszieher/ Internal extractor

Wärmebehandlung / Härte:
vergüteter Stahl/ tempered steel

Oberflächenbehandlung:

Artikelnummer / ZNR.:
21-6

Dokumentversion:
-

Schutzvermerk
ISO 16016
beachten