



Product datasheet

Product name Internal extractor







Product number 21-1

Product series

EAN 4021176010811



Technical attributes

Attribute name	Attribute value
 ball bearing ISO	6001; 6201; 6301; 6801; 6901; 16001; 16101; 61801; 61901; 62201; 62301; 6002; 6202; 6302; 6802; 6902; 16002; 61802; 61902
 inner diameter of ball bearing	12 - 16 mm (3/16 - 5/8 inch)
 effective depth	25 mm (1 inch)
 length of internal extractor	72 mm (2 7/8 inch)
 number of segments	2
 weight	0.1 kg

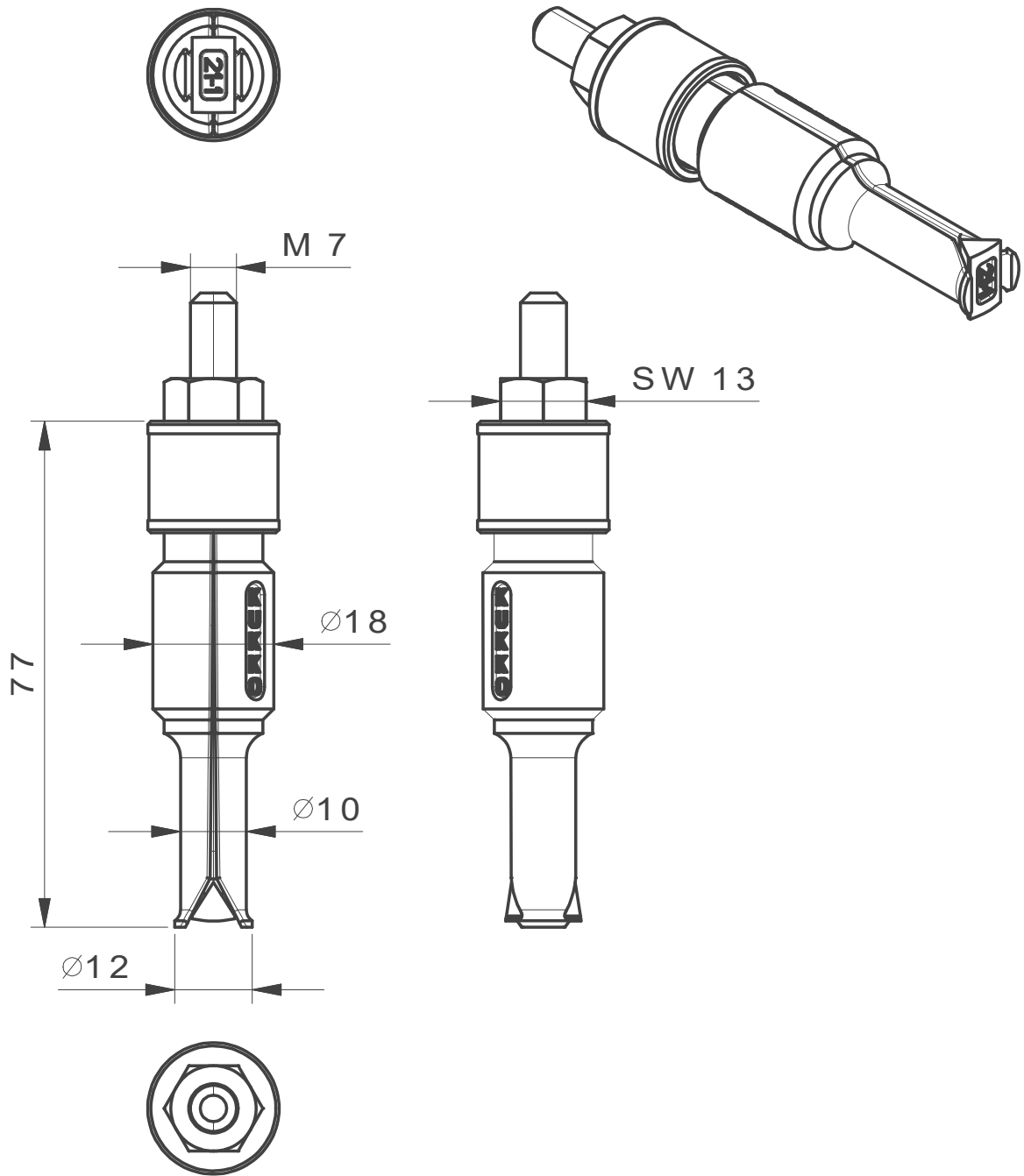

 <p>Kleinbongartz & Kaiser oHG Werkzeugfabrik Hilden - Germany</p>	Dokumentname: 21-1 Innenauszieher		Toleranz: DIN ISO 2768-m
	Dokumentbeschreibung: ZSB		Material: Hochfester extra zäher Vergütungsstahl/ High tensile strength and toughness steel
	Erstellt / Geprüft von: Schultes	Erstellungsdatum: 05/06/2015	Maßstab: 1:1
Teilbeschreibung: Innenauszieher/ Internal extractor		Wärmebehandlung / Härte: vergüteter Stahl/ tempered steel	
		Oberflächenbehandlung:	
Artikelnummer / ZNR.: 21-1	Dokumentversion: -	Schutzvermerk ISO 16016 beachten	